

Tubular motor:

GEIGER-SOLIDline (GU45.. F04)

Motor control:

GEIGER VW AIR

for rolling shutters, screens and open style folding arm awnings

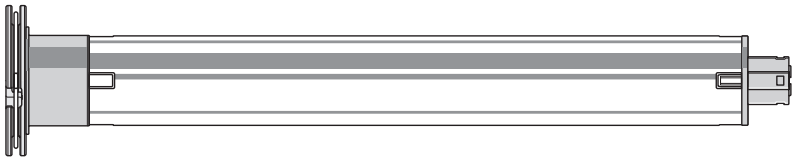

EN

**Original assembly and
operating instructions**

EN

Index

1. General information	2
2. Guarantee.....	2
3. Intended use	3
4. Safety instructions	3
5. Safety instructions for assembly	4
6. Installation instructions	5
7. Information for the specialist electrician	6
8. Operating modes of the GEIGER SOLIDline AIR.....	6
9. Programming/deleting the handheld or wall transmitter.....	7
10. Learning mode for end positions	8
11. Setting the end positions for rolling shutters and screens/ awnings	8
12. Setting the end positions	9
13. Intermediate position	13
14. Starting from the end positions	13
15. Grouped control	14
16. Setting the end positions of an open style folding arm awning ...	15
17. Connection to Loxone Miniserver	17
18. Obstacle recognition.....	18
19. End position correction	18
20. What to do if... ..	18
21. Declaration of conformity.....	19
22. Technical data.....	20
23. Maintenance.....	20
24. Notes on waste disposal	20

EN

1. General information

Dear customer,

By purchasing a GEIGER motor you have decided on a quality product from GEIGER.

Thank you very much for your decision and the confidence placed in us.

Before you put this drive into operation please observe the following safety instructions. It serves for the prevention of danger and for the avoidance of personal injury and damage to property.

The installation and operating instructions contain important information for the installer, the specialist electrician and the user. Please pass on these instructions if you transfer the product. These instructions should be kept by the user.

2. Guarantee

In the case of incorrect installation contrary to the installation and operating instructions and/or constructional modification, the legal and contractual guarantee for property damage and product liability lapses.

3. Intended use

The motors of the model range SOLIDline VW AIR with AIR radio technology are designed exclusively for the operation of rolling shutters, screens and open style folding arm awnings.

The motors may not be used for the operation of roller grilles, garage doors, furniture and lifting tools.

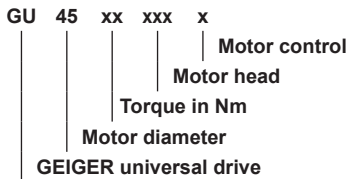

4. Safety instructions



ATTENTION: Important safety instructions. For personal safety, it is important to follow these instructions. Please keep these instructions for future reference.

- ▶ Do not allow children to play with stationary controls. Keep remote controls away from children.
- ▶ The installation is to be checked regularly for defective balance, signs of wear or damaged cables and springs, if relevant.
- ▶ Do observe the moving sun protection system and keep persons away until it has closed completely.
- ▶ When operating the manual release with the sun protection system open, please be cautious as it can fall down quickly if springs or tapes wear off or are broken.
- ▶ Do not operate the device if operations such as, for example, window cleaning are to be carried out in the vicinity.
- ▶ Disconnect the automatic controlled device from the mains power supply if operations such as, for example, window cleaning are being carried out in the vicinity.
- ▶ During operation observe the danger zone.
- ▶ Do not use the installation if people or objects are in the danger zone.
- ▶ Urgently shut down damaged installations until repair.
- ▶ Unconditionally shut down the unit during maintenance and cleaning operations.
- ▶ Pinching and shearing points are to be avoided and must be secured.
- ▶ This appliance can be used by children aged 8 and above and persons whose physical, sensorial or mental capacities are impaired, or who have no experience or know-how if they have been supervised or been given instructions on the use of the appliance and if they understand the possible resulting dangers. Children are not permitted to play with the device. Cleaning and maintenance should not be carried out by children.
- ▶ The rated sound pressure level is less than 70 dB(A).
- ▶ Disconnect the device from the mains power supply for maintenance and replacement of parts.
If the motor is disconnected via a plug connection the operator must be able to control - from any place to which it has access – that the plug is removed.
If this is not possible - due to design or installation - the disconnection from the power supply must be ensured via locking in the disconnected position (e.g. isolator).
- ▶ The motor tube can get very hot during prolonged use.
When working on the unit, do not touch the tube before it has cooled down.

EN

5. Safety instructions for assembly



ATTENTION: Important safety instructions. Follow all installation instructions, as incorrect installation can lead to serious injuries.

- ▶ When mounting the motor without any mechanical protection of the driven parts and of the tube which may become hot, the motor must be installed at a height of at least 2.5 m above the ground or of another level which provides access to the drive.
- ▶ Before the motor is installed, all cables which are not needed are to be removed and all equipment which is not needed for power-operated actuation is to be put out of operation.
- ▶ The actuating element of a manual release must be mounted at a height of less than 1.8 m.
- ▶ If the motor is controlled by a switch or pushbutton, the switch or pushbutton must be mounted within eyeshot of the motor. The switch or pushbutton must not be located in the vicinity of moving parts. The height of installation must be at least 1.5 m above the floor.
- ▶ Permanently installed control devices must be attached visibly.
- ▶ In case of devices extending horizontally, a horizontal distance of at least 0.4 m must be respected between the fully extended part and any other fixed element.
- ▶ The rated speed and the rated torque of the motor must be compatible with the device.
- ▶ The mounting accessories that are used must be designed in accordance with the selected rated torque.
- ▶ Good technical knowledge and good mechanical skills are necessary for the motor installation. Incorrect installation can lead to serious injury. Electrical work must be carried out by a qualified electrician in accordance with the regulations in force locally.
- ▶ Only use connecting cables that are suitable with the environmental conditions and which meet the construction requirements. (see accessories catalogue)
- ▶ If the device is not equipped with a connecting cable and a plug, or other means for disconnecting from the mains with a contact opening on each pole according to the conditions of the overvoltage category III for full disconnection, a disconnecting device of this type must be incorporated into the permanently installed electrical installation according to the wiring rules.
- ▶ Do not mount the connecting cables near hot surfaces.
- ▶ A plug for the disconnection of the motor from the power supply must be accessible after installation.
- ▶ Damaged connecting cables must be replaced by GEIGER connecting cables of the same type.
- ▶ The device must be mounted as described in the installation instructions. Fixations shall not be made with adhesives since they are regarded as unreliable.

EN

6. Installation instructions



Before fixing, the strength of the masonry or of the subsurface is to be checked.



Prior to installation please check to ensure there is no visible damage to the motor like cracks or open cables.



Caution: If the tube is screwed/riveted to the drive, the measure must be taken from the tube end to the center of the drive and marked on the tube.

When drilling the winding shaft never drill into the area of the tubular motor!

When inserting into the shaft, the tubular motor must not be struck and must not be allowed to fall into the shaft.

Installation into the rolling shutter:

Fix motor support to available stud bolts or in the side frame.

Insert motor into the shaft with a suitable adapter and drive up to the stop of the shaft adapter.

Insert roller capsule on the opposite side.

Put shaft with motor on motor support or on pivoting engine bearer. On the opposite side pull out roller capsule until bolt fits into ball bearing.

Screw together roller capsule with shaft.
Screw together shaft with tubular carrier.

Fix rolling shutter casing to shaft.

Alternative: Use fixation plates for front box units. Attach the motor. The bearing locks into place. To loosen, turn the spring washer.

Installation into awnings and screens:

Insert motor with a suitable adapter and drive into the shaft up to the stop of the shaft adapter.

Fix the motor support on the awning. Fix the motor together with the shaft on the motor support. The bearer locks into place.

Depending on the selected motor head, different fixation systems can be used:

- Place the motor with square insert in the star-shaped bearer and lock with pin
- Place the motor into the existing engine bearer and lock
- Place the motor in a compatible engine bearer with clip system and lock with spring or rotating lever



The GEIGER SOLIDline motor is suitable for shaft diameters from 50 mm.

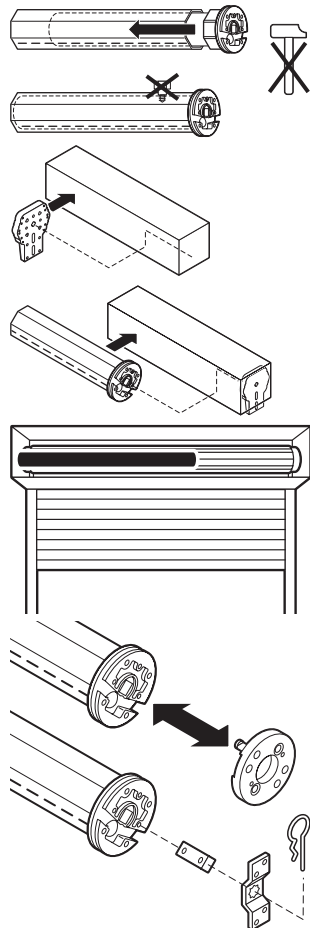

EN

7. Information for the specialist electrician



CAUTION / IMPORTANT NOTE

- The black wire of the connecting cable can be under power.
- The black wire must be fully insulated for touch-safe operations.
- The connecting cable may be shortened. A minimum length of 20 cm must be respected.
- The open end of the black wire must be insulated with an insulated clamp or other insulated material.
- When replacing the connecting cable, please use the cable type M56E699 and respect the connecting instructions.



Caution: Important installation instructions. Please follow all instructions since incorrect installation can lead to the destruction of the motor and the switching unit.

The operations with the service clamps may be accomplished only by an electrical specialist.
Motors with electronic limit stops can be connected in parallel.

In this case the maximum load of the switching unit must not be exceeded.

When changing the running direction the switchover must be effected through an off-position.

When changing the running direction the switchover time must be at least 0.5 s.

With a three-phase network, please use the same external conductor in order to control the UP and DOWN directions.

PVC cables are not suitable for equipment used outdoors or exposed to prolonged high levels of UV radiation. These cables should not be used if they are likely to touch metal parts that can heat up to temperatures exceeding 70°C.

Connecting cables with plug connectors of the Hirschmann Company are tested and approved with couplings of the Hirschmann Company.

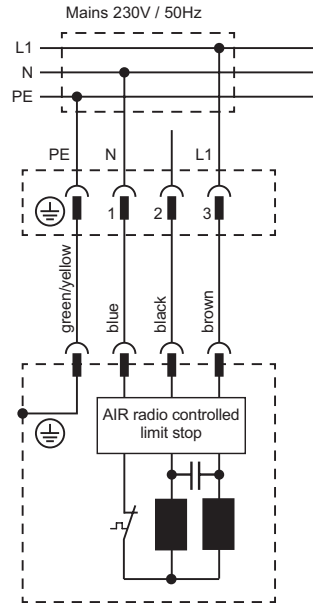

EN

8. Operating modes of the GEIGER SOLIDline AIR

The motor can be operated in two ways:

- Individual control: the motor is operated with a handheld or wall transmitter
- Smart Home control: the motor is connected, configured and operated with a Loxone Miniserver or a Loxone Miniserver Go.

A subsequent change between individual control and Smart Home control is possible by repeated teaching in of the motor.

Please find below the commissioning/ operating instructions concerning the individual control with handheld or wall transmitter.

The commissioning/ operating instructions with a Loxone Miniserver or Loxone Miniserver Go are under point 17.

9. Programming/deleting the handheld or wall transmitter

In Smart Home mode, the handheld or wall transmitters can be directly programmed on the Loxone Miniserver. For more information please refer to the assembly and operation instructions of the transmitters or click: www.loxone.com/help/lcair

Activate the learning mode

Connect the motor with the electrical power supply. Switch on mains.

The motor makes two short movements (2 x „click“).

The learning mode is now available for the next 30 minutes.

Press the RIGHT and LEFT keys of the transmitter simultaneously for about 10 seconds until the channel LED flashes. The transmitter is now in the learning mode.

Press the STOP key for about 1,5 seconds. The motor which is nearest to the transmitter or which has the best reception confirms the learning mode (2 x „click“).



Should the improper motor be selected, move closer to the motor you need.

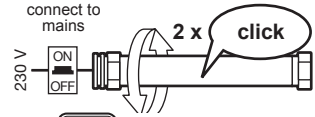

◀ and ▶
approx. 10 sec.

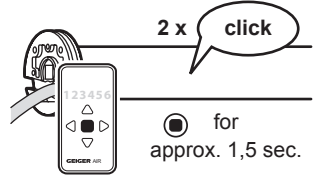

● for
approx. 1,5 sec.

Learning the handheld or wall transmitter



The learning mode must be activated and the motor must be selected first in order to learn/delete the transmitter.

Select on the transmitter the channel on which the motor should be operated.

Press STOP and UP keys for approximately 1,5 seconds.

The motor confirms (1 x „click“). The selected channel is programmed in the motor.

In order to learn further channels: Select channel on the transmitter and press STOP and UP keys for 1.5 seconds.

Up to 5 different channels can be learned.

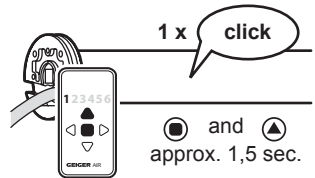

● and ▲
approx. 1,5 sec.

Deactivate the learning mode

To deactivate the learning mode, press the LEFT and RIGHT keys simultaneously for about 4 seconds until the channel LED stops blinking. The learning mode is deactivated.



◀ and ▶
approx. 4 sec.

Delete the learned handheld or wall transmitter



The learning mode must be activated and the motor must be selected first in order to learn/delete the transmitter.

Select on the transmitter the channel which should be deleted.

Press STOP and DOWN keys for approximately 1,5 seconds.

The motor confirms (4x „click“). The selected channel is deleted in the motor.

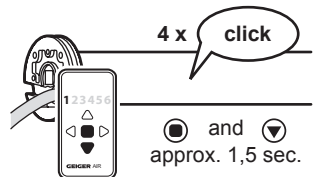

● and ▼
approx. 1,5 sec.

Deactivate the learning mode

To deactivate the learning mode, press the LEFT and RIGHT keys simultaneously for about 4 seconds until the channel LED stops blinking. The learning mode is deactivated.



◀ and ▶
approx. 4 sec.

EN

10. Learning mode for end positions

Activate the learning mode for end positions

Connect the motor with the electrical power supply. Switch on mains.

The motor makes two short movements (2 x „click“).

The learning mode is now available for the next 30 minutes.

Press the UP and DOWN keys of the transmitter simultaneously for about 10 seconds until all channel LEDs flash alternately. The transmitter is now in the learning mode.

Press the STOP key for about 1,5 seconds. The motor which is nearest to the transmitter or which has the best reception confirms the learning mode for end positions (2 x „click“).

Should the improper motor be selected, move closer to the motor you need.

Press LEFT and STOP keys for about 1,5 seconds to activate the learning mode for end positions. The motor confirms with a short movement (1 x „click“).

The motor jerks (start, stop, start) at each run command to confirm the learning mode for end position activation.

Deactivate the learning mode for end positions

To deactivate the learning mode for end positions, press simultaneously the UP and DOWN keys of the transmitter for about 4 seconds until the channel LEDs stop blinking. The learning mode for end positions is now deactivated.

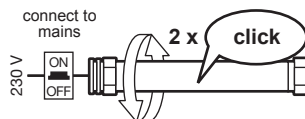

▲ and ▼
approx. 10 sec.

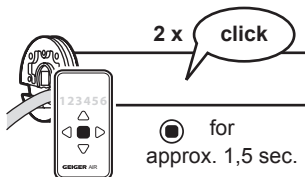

■ for
approx. 1,5 sec.

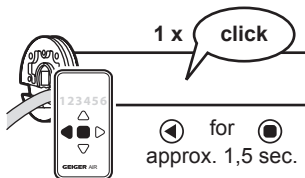

◀ for ■
approx. 1,5 sec.



▲ and ▼
approx. 4 sec.

11. Setting the end positions for rolling shutters and screens/awnings

EN

	Following installation types are possible:	The rolling shutter is equipped with:	Screen/awning is equipped with:
A	Lower and upper end positions with stop	With anti-lift device / End bar with stopper	–
B	Lower end position with stop / Upper end position freely adjustable	With anti-lift device / End bar without stopper	–
C	Lower end position freely adjustable / Upper end position with stop	Without anti-lift device / End bar with stopper	End bar/awning arms used as stops
D	Lower and upper end positions freely adjustable	End bar without stopper / Without anti-lift device	No stops

The learning mode for end positions must be activated first in order to set/modify the end positions (see point 10).

Please note: The key assignment for UP or DOWN takes place automatically when both end positions are stored.

Change/delete the end positions

In order to change or delete the end positions, a new programming must be started.

12. Setting the end positions



The learning mode for end positions must be activated first in order to set the end positions (see point 10).



Please note: the lower end position must be learned first.

Variant A:

Lower and upper end position with stop

Lower end position:

Press the UP or DOWN key and keep it pressed until the sun protection has reached the lower stop and the motor switches off automatically.

The motor confirms with 2 x „click“.

The lower end position is now stored.

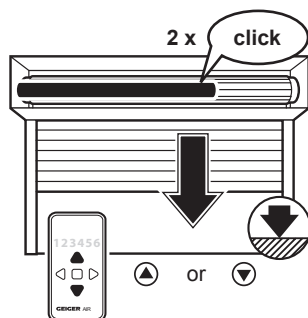

Upper end position:

Press the UP or DOWN key and keep it pressed until the sun protection has reached the upper stop and the motor switches off automatically.

The motor confirms with 4 x „click“.

The upper end position is now stored.

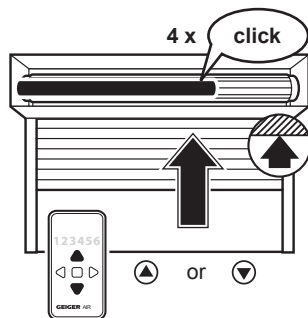

The UP and DOWN keys are now assigned to the corresponding rotation direction of the motor.

Deactivate the learning mode for end positions

To deactivate the learning mode for end positions, press simultaneously the UP and DOWN keys of the LC AIR transmitter for about 4 seconds until the channel LEDs stop blinking. The learning mode for end positions is now deactivated.



▲ and ▼
approx. 4 sec.

EN

Variant B:

Lower end position with stop / Upper end position freely adjustable



The learning mode for end positions must be activated first in order to set the end positions (see point 10).



Please note: the lower end position must be learned first.

Lower end position:

Press the UP or DOWN key and keep it pressed until the sun protection has reached the lower stop and the motor switches off automatically.

The motor confirms with 2 x „click“.

The lower end position is now stored.

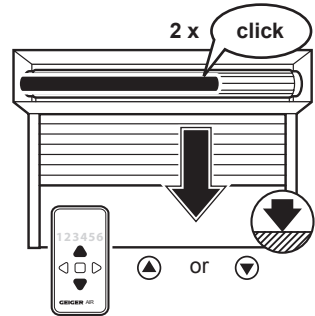

Upper end position:

Press the UP or DOWN key and keep it pressed until the sun protection has reached the desired upper end position. Corrections with UP or DOWN key are possible.

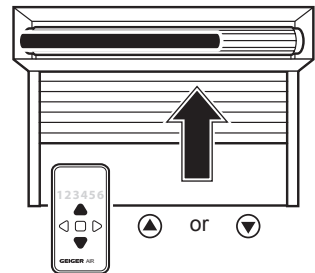

Store upper end position:

Press the STOP and RIGHT keys simultaneously for about 1,5 seconds. The motor confirms with 4 x „click“.



The UP and DOWN keys are now assigned to the corresponding rotation direction of the motor.

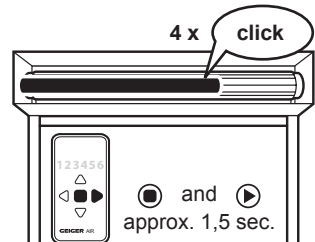

Deactivate the learning mode for end positions

To deactivate the learning mode for end positions, press simultaneously the UP and DOWN keys of the transmitter for about 4 seconds until the channel LEDs stop blinking. The learning mode for end positions is now deactivated.



Variant C:

Lower end position freely adjustable / Upper end position with stop



The learning mode for end positions must be activated first in order to set the end positions (see point 10).



Please note: the lower end position must be learned first.

Lower end position:

Press the UP or DOWN key and keep it pressed until the sun protection has reached the desired lower end position. Corrections with UP or DOWN key are possible

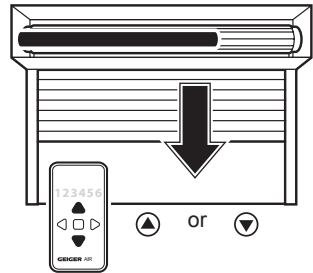

Store lower end position:

Press the STOP and RIGHT keys simultaneously for about 1,5 seconds. The motor confirms with 2 x „click“.

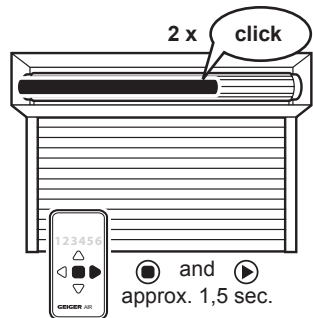

Upper end position:

Press the UP or DOWN key and keep it pressed until the sun protection has reached the upper stop and the motor switches off automatically.

The motor confirms with 4 x „click“.

The upper end position is now stored.



The UP and DOWN keys are now assigned to the corresponding rotation direction of the motor.

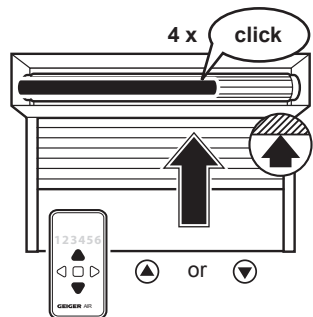

Deactivate the learning mode for end positions

To deactivate the learning mode for end positions, press simultaneously the UP and DOWN keys of the transmitter for about 4 seconds until the channel LEDs stop blinking. The learning mode for end positions is now deactivated.



EN

Variant D: Lower and upper end positions freely adjustable



The learning mode for end positions must be activated first in order to set the end positions (see point 10).



Please note: the lower end position must be learned first.

Lower end position:

Press the UP or DOWN key and keep it pressed until the sun protection has reached the desired lower end position. Corrections with UP or DOWN key are possible

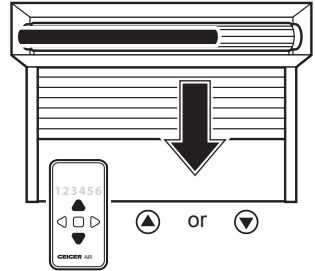

Store lower end position:

Press the STOP and RIGHT keys simultaneously for about 1,5 seconds. The motor confirms with 2 x „click“.

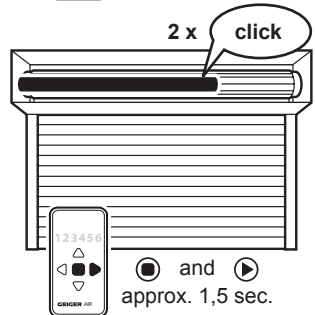

Upper end position:

Press the UP or DOWN key and keep it pressed until the sun protection has reached the desired upper end position. Corrections with UP or DOWN key are possible.

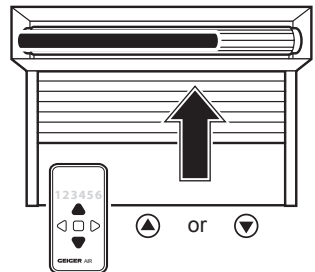

Store upper end position:

Press the STOP and RIGHT keys simultaneously for about 1,5 seconds. The motor confirms with 4 x „click“.

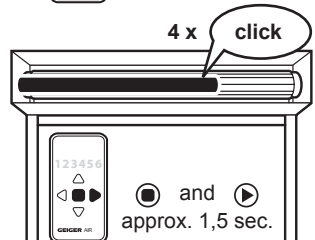

The UP and DOWN keys are now assigned to the corresponding rotation direction of the motor.

Deactivate the learning mode for end positions

To deactivate the learning mode for end positions, press simultaneously the UP and DOWN keys of the transmitter for about 4 seconds until the channel LEDs stop blinking. The learning mode for end positions is now deactivated.



approx. 4 sec.

13. Intermediate position

Learning the intermediate position

Travel from any position to the selected end position, stop with the opposite key and hold key pressed for approx. 1,5 sec. until the motor responds (2 „click“). Then release the key.

The intermediate position is now stored.

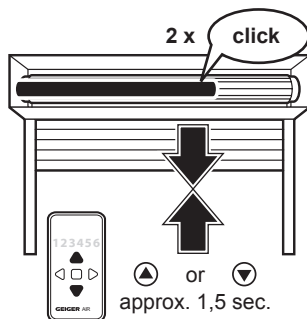

Changing the intermediate position

See “learning the intermediate position“ and select a new intermediate position.

Deleting the intermediate position

Stop the sun protection from UP or DOWN movement with the opposite key and keep key pressed for about 5 sec. until the motor responds (4 x „click“).

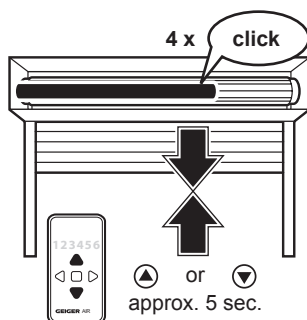

14. Starting from the end positions

No intermediate position has been programmed:

To start from the end positions, a short key pressure in the corresponding direction of movement is sufficient.

To stop the movement, a short key pressure in the opposite direction is sufficient or use stop key.

An intermediate position is programmed :

To start from the end positions, the key corresponding to the correct direction of movement must be pressed **for at least 1,5 seconds**.

With a short key press of **less than 1.5 seconds**, the **intermediate position** is travelled to. For stopping the travel movement a **short** key press in the opposite direction is sufficient or use stop key.

EN

15. Grouped control

(also see point 9 Programming/deleting the LC AIR handheld or wall transmitter)

Operation: individual or grouped control of sun protection A and sun protection B with 6-channel transmitter LC AIR

Connect the motor with the electrical power supply. Switch on mains. The motor makes two short movements (2 x „click“).

Press the RIGHT and LEFT keys of the transmitter LC AIR simultaneously for about 10 seconds until the channel LED flashes. The transmitter is now in the learning mode.

Sun protection A:

1. Press STOP key 1,5 seconds to select the motor
2. Select the channel (here channel 1) with LEFT or RIGHT key
3. Press STOP and UP keys simultaneously 1,5 seconds to learn the channel

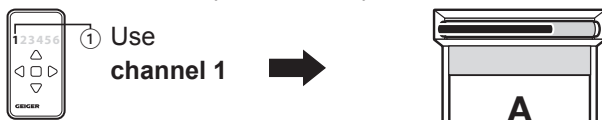

4. Select the group channel (here channel 3) with LEFT or RIGHT key
5. Press STOP and UP keys simultaneously 1,5 seconds to learn the channel



Sun protection B:

1. Press STOP key 1,5 seconds to select the motor
2. Select the channel (here channel 2) with LEFT or RIGHT key
3. Press STOP and UP keys simultaneously 1,5 seconds to learn the channel



4. Select the group channel (here channel 3) with LEFT or RIGHT key
5. Press STOP and UP keys simultaneously 1,5 seconds to learn the channel



If an operating command is now given for the **channel 1**, the **sun protection A** opens or closes.

If the operation command is given for **channel 2**, the **sun protection B** opens or closes.

In order to open or close both **sun protection systems A and B** simultaneously, you must select **channel 3** and give the desired operation command.

16. Setting the end positions of an open style folding arm awning

Variant C:

Lower end position freely adjustable / Upper end position with stop



The learning mode for end positions must be activated first in order to set the end positions (see point 10).



Please note: the lower end position must be learned first.

Lower end position:

Press the UP or DOWN key and keep it pressed until the sun protection has reached the desired lower end position. Corrections with UP or DOWN key are possible

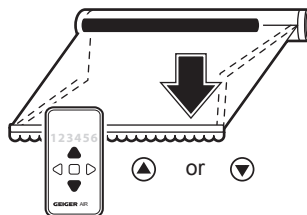

Store lower end position:

Press the STOP and RIGHT key for about 1,5 seconds. The motor confirms with 2 x „click“.

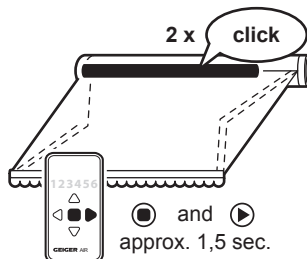

Upper end position:

Press the UP or DOWN key and keep it pressed until the sun protection has reached the upper stop and the motor switches off automatically.

The motor confirms with 4 x „click“.

The upper end position is now stored.

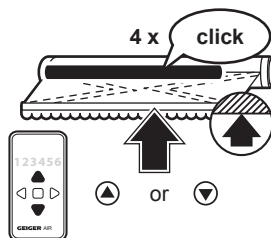

The UP and DOWN keys are now assigned to the corresponding rotation direction of the motor.

Deactivate the learning mode for end positions

To deactivate the learning mode for end positions, press simultaneously the UP and DOWN keys of the transmitter for about 4 seconds until the channel LEDs stop blinking. The learning mode for end positions is now deactivated.



▲ and ▼
approx. 4 sec.

EN

Variant D:

Lower and upper end positions freely adjustable



The learning mode for end positions must be activated first in order to set the end positions (see point 10).



Please note: the lower end position must be learned first.

Lower end position:

Press the UP or DOWN key and keep it pressed until the sun protection has reached the desired lower end position. Corrections with UP or DOWN key are possible

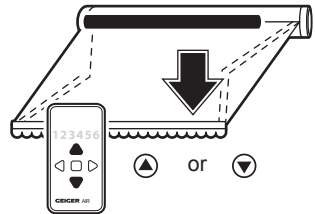

Store lower end position:

Press the STOP and RIGHT key for about 1,5 seconds. The motor confirms with 2 x „click“.

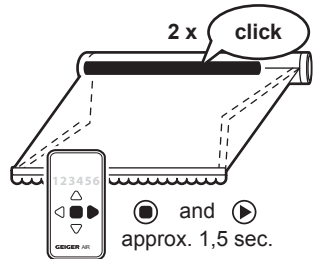

Upper end position:

Press the UP or DOWN key and keep it pressed until the sun protection has reached the desired upper end position. Corrections with UP or DOWN key are possible.

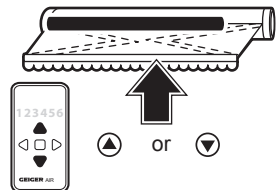

Store upper end position:

Press the STOP and RIGHT key for about 1,5 seconds. The motor confirms with 4 x „click“.



The UP and DOWN keys are now assigned to the corresponding rotation direction of the motor.



Deactivate the learning mode for end positions

To deactivate the learning mode for end positions, press simultaneously the UP and DOWN keys of the transmitter for about 4 seconds until the channel LEDs stop blinking. The learning mode for end positions is now deactivated.



17. Connection to Loxone Miniserver

Conditions

In order to integrate the SOLIDline AIR in your Loxone system, a Miniserver Go or a Miniserver with Air Base Extension must be operational.

More information under: www.loxone.com/help/miniserver

Commissioning in Loxone Config

In order to learn the GEIGER SOLIDline AIR, the learning mode must be activated. The learning mode is automatically activated for 30 minutes when the power supply is switched off and then on again.

The current Loxone Config software is available for download here:
www.loxone.com/download

Connect with your Miniserver and switch on the Air Monitor. Click on the Air Base Extension and activate the “Air Monitor” checkbox.

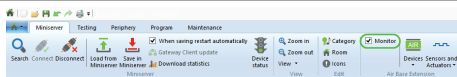

With one click on “start search” search for Air devices in learning mode. All Air devices that are in the learning mode will be listed.

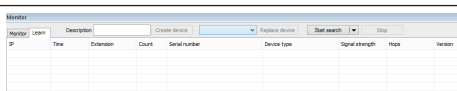

Select the requested device, enter a name and finally click on “create device”.

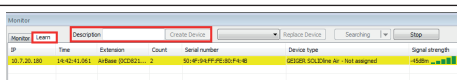

The device is now shown in the peripheral window. The module “automatic blinds integrated” is automatically created by drag and drop on the respective page. This module is automatically connected to the selected motor.

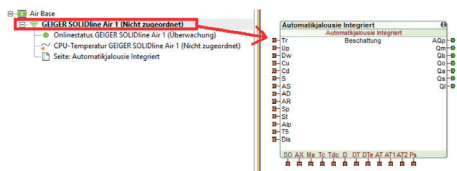

Configuration in Loxone Config

For configuration, operation and visualization of the GEIGER SOLIDline AIR with Loxone please use the module “automatic blinds integrated”. You can assign it to the motors that are already learnt under block properties “assigned motors”. This occurs automatically if, as mentioned above, the motor has been moved by drag & drop on the configuration page. Please visit our website www.loxone.com/help/solidline for more information on configuration of the GEIGER SOLIDline AIR with Loxone Miniserver.

EN

18. Obstacle recognition

When, after the teaching of the first complete, uninterrupted travel from one end position to the other end position is carried out, the torque needed is learnt.

In any following complete, uninterrupted travel from end position to end position, the torque needed is automatically reset. Slow changes in the installation due to ageing, soiling, cold or heat are thus automatically taken into consideration.

If a travel movement in UP direction is blocked by an obstacle, the motor switches off and a small return motion takes place.

The running direction in which the obstacle was recognized is blocked.

The block is removed if the motor has been operated in the opposite direction for a certain time. An obstacle must thus first be released before the motor can be operated again in the direction of the obstacle.

19. End position correction



The engine needs to be taught with the end stops (stopper and anti-lift device).

Checking of the end position, and if appropriate an end position correction, takes place after 1, 5, 20, and then every 50 cycles.

Should a hangings elongation have resulted, due to temperature changes, this is corrected at the next end position correction.

If, due to temperature changes, modified winding behaviour should arise and the hangings should run against the stop, an immediate end position correction takes place. In addition, the counter for the end position correction is started afresh.

20. What to do if...

Problem	Lösung
Motor does not run till end position.	<ul style="list-style-type: none"> • An intermediate position has been learned.
Motor does not run.	<ul style="list-style-type: none"> • Motor not plugged in. Please check the plug connection. • Check connecting cable for possible damage. • Check the mains voltage and allow the cause of the voltage breakdown to be tested by a specialist electrician.
Motor runs upwards, rather than downwards.	<ul style="list-style-type: none"> • End position order was not observed. • Reset end stops
Transmitter does not operate.	<ul style="list-style-type: none"> • Check the battery. • Inadvertent deletion of the transmitter. Start learning again
After several runs, the motor remains still and no longer reacts.	<ul style="list-style-type: none"> • The motor has become too hot and has turned itself off. Try again after a cooling period of approx. 15 min.
No channel assignment possible.	<ul style="list-style-type: none"> • The learning mode time (30 minutes) is over. Disconnect the motor and repeat the operation
No possible learning of the end positions.	<ul style="list-style-type: none"> • The learning mode time (30 minutes) is over. Disconnect the motor and repeat the operation
The motor jerks during starting (start, stop, start).	<ul style="list-style-type: none"> • The motor is in learning mode. The minimum travel distance might have been under passed.

21. Declaration of conformity



EU Declaration of Conformity

Gerhard Geiger GmbH & Co. KG
Antriebstechnik
Schleifmühle 6
D-74321 Bietigheim-Bissingen

Product designation:

Venetian blinds motor, motor for rolling shutters, motor for awnings

Type designation:

GJ56..
GR45..
GU45..
GSI56..

Applied directives:

2006/42/EC
2014/30/EU
1999/5/EC
2011/65/EU

Applied standards:

DIN EN 60335-1
DIN EN 60335-2-97
DIN EN 62233
DIN EN 55014-1
DIN EN 55014-2
DIN EN 61000-3-2
DIN EN 61000-3-3
ETSI EN 300 220-2
ETSI EN 301 489-1
ETSI EN 301 489-3

Authorized representative for technical data:

Gerhard Geiger GmbH & Co. KG

Address:

Schleifmühle 6, D-74321 Bietigheim-Bissingen

Bietigheim-Bissingen, 02.01.2017



Dr. Marc Natusch (General Manager)

100M1518 en 0117

EN

Current declarations of conformity are available under www.geiger.de

22. Technical data

Technical data of tubular motor SOLIDline-KS (GU45..)					
	GU4510	GU4520	GU4530	GU4540	GU4550
Voltage	230V~/50Hz				
Current	0,47 A	0,63 A	0,8 A	1,0 A	1,0 A
Cos Phi (cosφ)	>0,95				
Inrush current (factor)	x 1,2				
Power	105 W	140 W	180 W	220 W	220 W
Torque	10 Nm	20 Nm	30 Nm	40 Nm	50 Nm
Speed	16 rpm	16 rpm	16 rpm	16 rpm	12 rpm
Protection class	IP 44				
Total length¹⁾	516,5 mm	546,5 mm	566,5 mm	586,5 mm	586,5 mm
Operating mode	S2 4 min	S2 5 min	S2 4 min	S2 4 min	S2 4 min
Sound pressure level²⁾	39 dB(A)	41 dB(A)	41 dB(A)	43 dB(A)	-
Diameter	45 mm				
Weight	approx 1,90 kg	approx 2,20 kg	approx 2,40 kg	approx 2,70 kg	approx 2,70 kg
Storage temperature/ Humidity	T = -15°C .. +70°C / dry and non-condensing place				

¹⁾ **SOLIDline-COM** + 3,5 mm / **SOLIDline-SOC**: + 3 mm / **SOLIDline-SIL**: ± 0 mm (without trunnion)

²⁾ The average sound pressure level data are intended for guidance only. The values were determined by GEIGER at a distance of 1 m, with a hanging motor at idle speed and averaged over 10 seconds. There is no reference to any specific test standard.

Subject to technical modifications



23. Maintenance

The drive is maintenance-free.

24. Notes on waste disposal

Recycling of packaging materials

In the interest of environmental protection, please contact your local government's recycling or solid waste management department to learn more about the services it provides.

Waste disposal of electric and electronic equipment

Electrical and electronic equipment must be collected and disposed of separately in accordance with EU regulations.

EN

For technical questions, please call our service team at: +49 (0) 7142 938-333. They will be happy to assist you.



Gerhard Geiger GmbH & Co. KG
 Schleifmühle 6
 D-74321 Bietigheim-Bissingen
 Telephone: +49 (0) 7142 938-0
 Telefax: +49 (0) 7142 938-230
 E-Mail: info@geiger.de
 Internet: www.geiger.de

